

# Ultra Low Phase Noise Crystal Oscillator



## SOMC-330

### Feature

- Hermetically seam-sealed ceramic package: 14.3×9.14×4.9mm
- Ultra Low Jitter Performance (Typical): 35fs@49.152MHz
- Supply voltage: 1.8V, 2.5V, 3.3V
- Low current Consumption
- Pb-free/RoHS Compliant | MSL Level 1
- Tight frequency stability options available

### Applications

- Audio applications
- Network Communication



### Electrical Specifications

Item	Symb.	Min.	Typ.	Max.	Unit	Notes
Frequency Range	Freq.	1	—	54	MHz	
Operating Temperature	T <sub>use</sub>	-40	—	+85	°C	
Storage Temperature Range	T <sub>stg</sub>	-55	—	+155	°C	
Supply Voltage	V <sub>dd</sub>	2.97	3.3	3.63	V	
		2.25	2.5	2.75	V	
		1.62	1.8	1.98	V	
Output Load(CMOS)	L <sub>CMOS</sub>	15			pF	
Current Consumption	I <sub>cc</sub>	—	—	10	mA	1MHz ≤ Freq. < 40MHz, L <sub>CMOS</sub> = 15pF
		—	—	20		40MHz ≤ Freq. ≤ 54MHz, L <sub>CMOS</sub> = 15pF
Duty Cycle	SYM	45	—	55	%	50% V <sub>dd</sub> level, L <sub>CMOS</sub> ≤ 15pF
Output Voltage	V <sub>OH</sub>	0.9V <sub>dd</sub>	—	—	V	
	V <sub>OL</sub>	—	—	0.1V <sub>dd</sub>		
Enable Voltage High	V <sub>IH</sub>	0.7V <sub>dd</sub>	—	—	V	Output will be disable if OE is Logic"0" Output will be enable if OE is Logic"1" or open
Disable Voltage Low	V <sub>IL</sub>	—	—	0.3V <sub>dd</sub>		
Rise / Fall Time	T <sub>R</sub> / T <sub>F</sub>	—	—	5	nS	10% V <sub>dd</sub> to 90% V <sub>dd</sub> level
Start-up time	T <sub>str</sub>	—	—	5	mS	To 90% of Final Amplitude
RMS Phase Jitter	PJ	Please see Table2 below				Offset: 12kHz to 20MHz
Aging	f <sub>age</sub>	-3	—	+3	ppm	at 25°C ± 3°C. First Year

### Electrical Specifications Cont.

• Table 1: Frequency Stability VS. Temperature

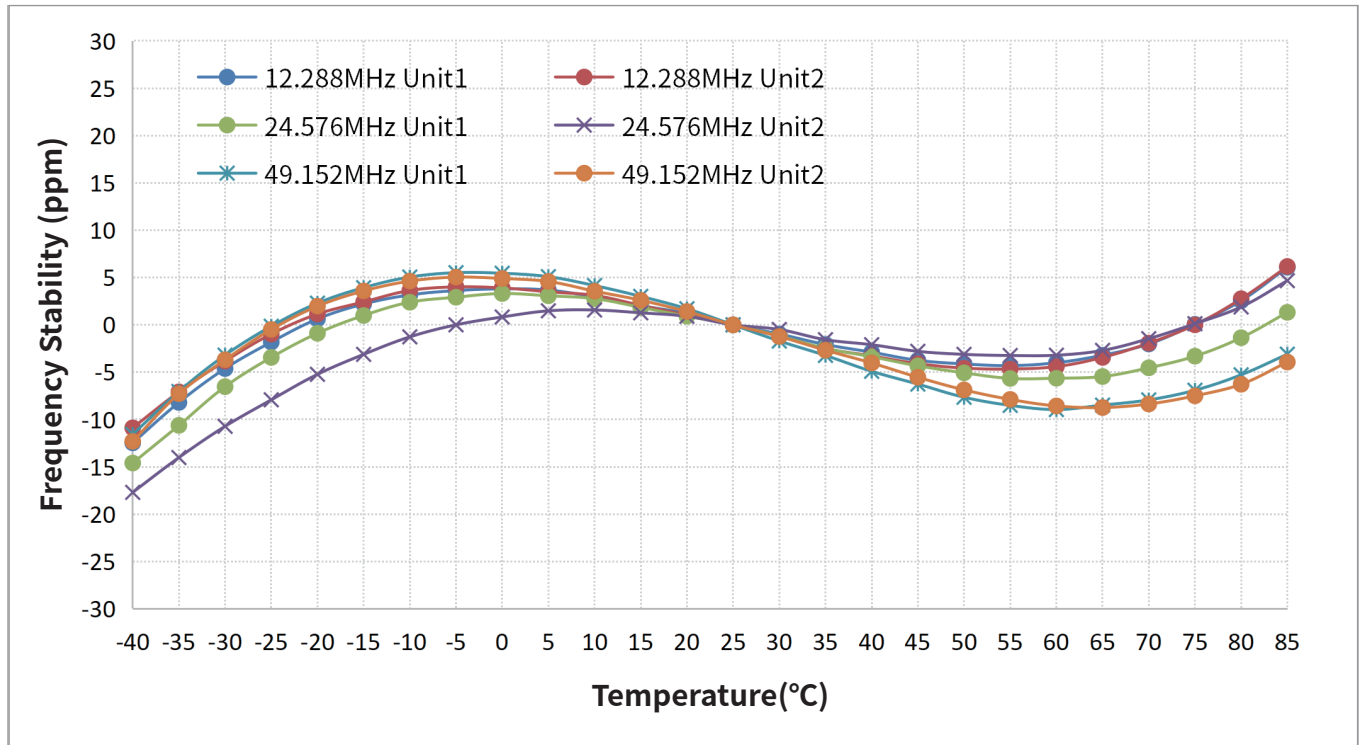

• Table 2: RMS Phase Jitter (Offset: 12kHz to 20MHz)

Frequency	RMS Jitter (Typical)	
	Supply Voltage = 1.8V	Supply Voltage = 3.3V
16.9344MHz	115.297fs	58.248fs
22.5792MHz	82.155fs	42.562fs
24.000MHz	81.626fs	38.42fs
24.576MHz	76.742fs	39.112fs
45.1584MHz	94.777fs	37.804fs
49.152MHz	88.911fs	34.496fs
50.000MHz	89.53fs	35.572fs

## SOMC-330

• Table 3: Phase Noise Plots (Unit: dBc/Hz)

Supply Voltage	Frequency (16.9344MHz)						
	10Hz	100Hz	1kHz	10kHz	100kHz	1MHz	5MHz
1.8V	-109.5395	-138.3870	-161.0267	-164.8481	-169.5420	-168.5496	-168.2729
3.3V	-112.9508	-140.7674	-164.4641	-172.3692	-174.8440	-175.2358	-174.4769

Frequency: 16.9344MHz Vdd=1.8V

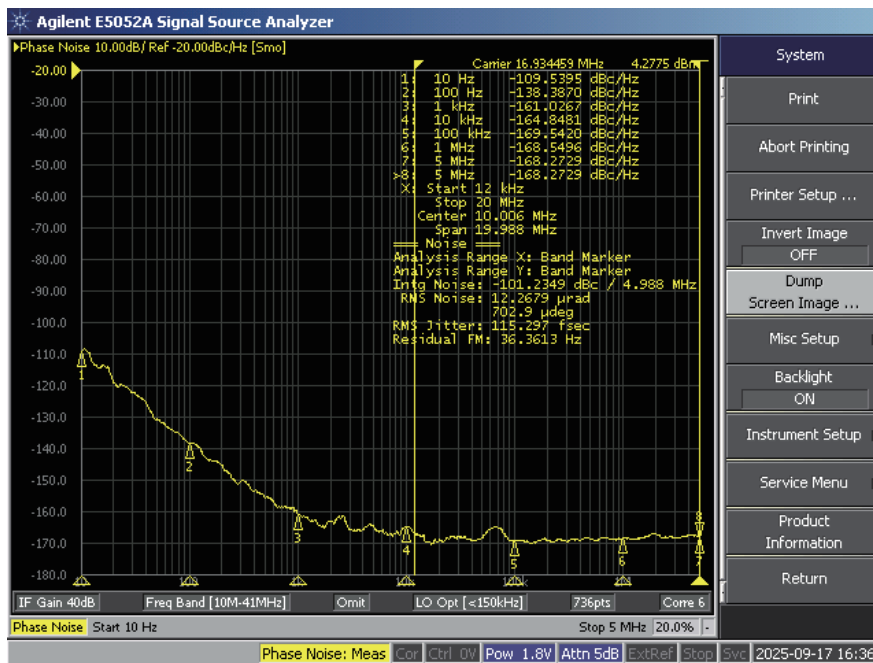

Frequency: 16.9344MHz Vdd=3.3V



# Ultra Low Phase Noise Crystal Oscillator



## SOMC-330

### Dimensions (UNIT:mm)

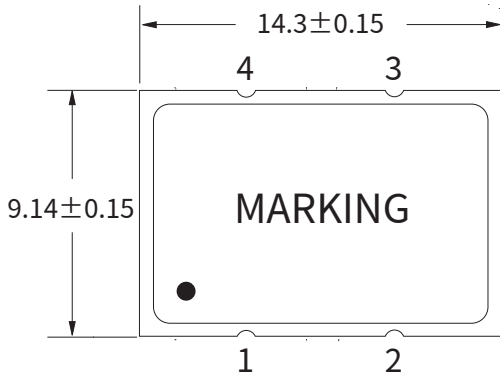

• TOP VIEW

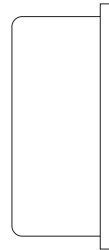

• SIDE VIEW

Pin	Function
1	Enable Control
2	GND
3	Output
4	Vdd

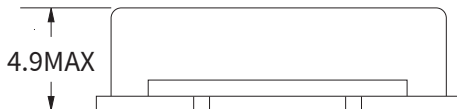

• SIDE VIEW

• SOLDER PAD LAYOUT

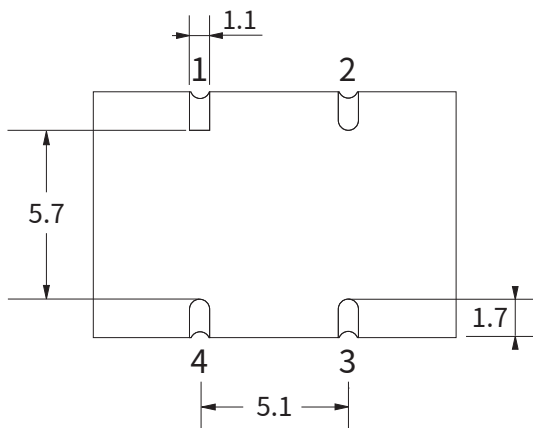

• BOTTOM VIEW

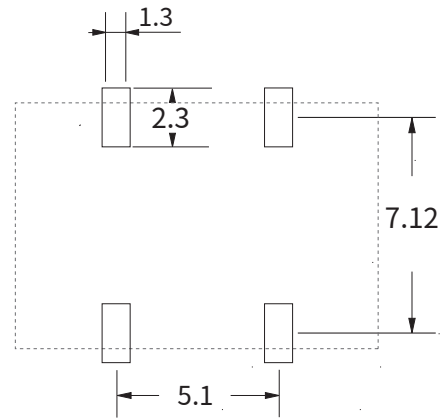

### Marking Information

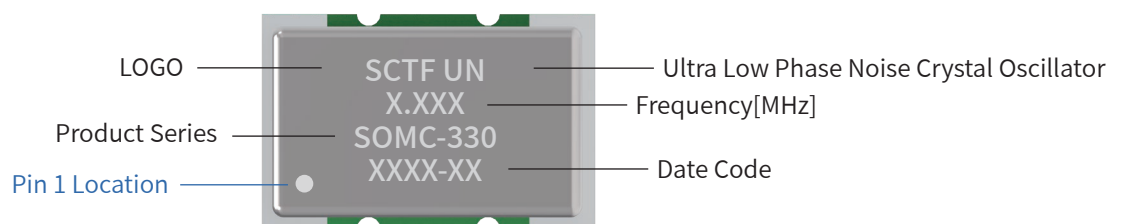

## Options and Part Identification

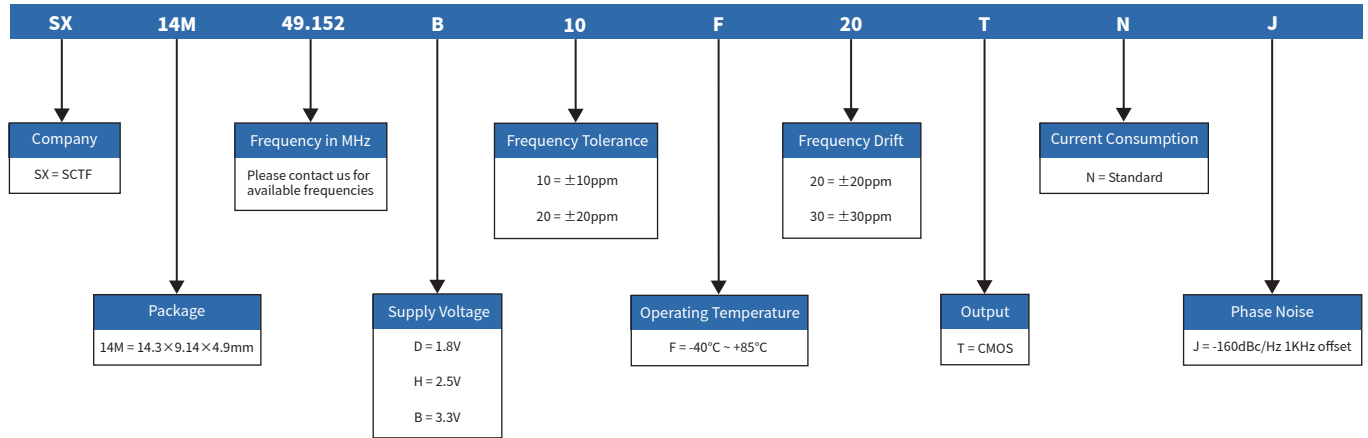

## List of available part numbers

Part NO#			
SX14M16.9344B10F20TNJ	SX14M22.5792B10F20TNJ	SX14M24.000B10F20TNJ	SX14M24.576B10F20TNJ
SX14M45.1584B10F20TNJ	SX14M49.152B10F20TNJ	SX14M50.000B10F20TNJ	

## Reflow Profile

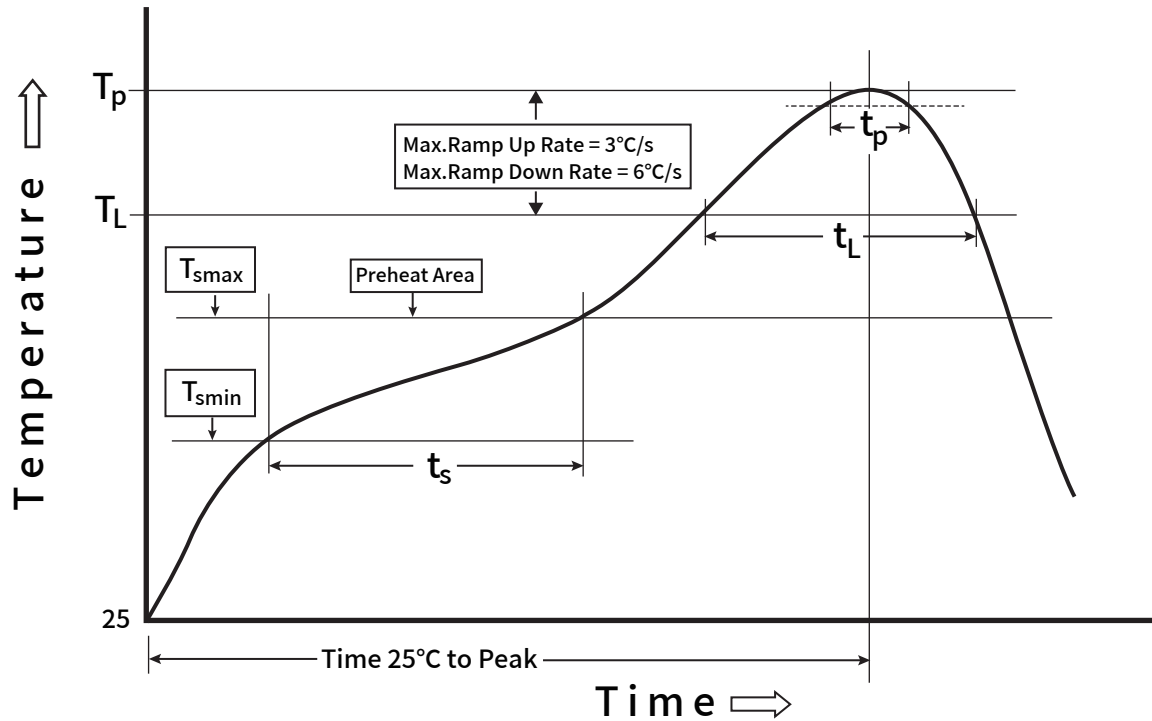

Profile Feature	Sn - Pb Eutectic Assembly	Preheat / Soak
Preheat / Soak <ul style="list-style-type: none"> <li>● Temperature Min ( Ts min )</li> <li>● Temperature Max ( Ts max )</li> <li>● Time ( Ts min to Ts max )</li> </ul>	100°C 150°C 60-120 seconds	150°C 200°C 60-120 seconds
Ramp - up rate ( TL to Tp )	3°C/ second max.	3°C/ second max.
Time maintained above <ul style="list-style-type: none"> <li>● Liquidous temperature ( TL )</li> <li>● Time ( tL ) maintained above TL</li> </ul>	183°C 60-150 seconds	217°C 60-150 seconds
Peak package body temperature ( Tp )	235°C	260°C
Time within 5° C of the specified classification temperature ( Tp )	20 seconds	30 seconds
Ramp - down rate ( Tp to TL )	6°C/ second max.	6°C/ second max.
Time 25° C to peak temperature	6 minutes max.	8 minutes max.
<b>Suggest reflow times</b>	<b>2 Times max.</b>	

# Ultra Low Phase Noise Crystal Oscillator



■ SOMC-330

## Testing Circuit

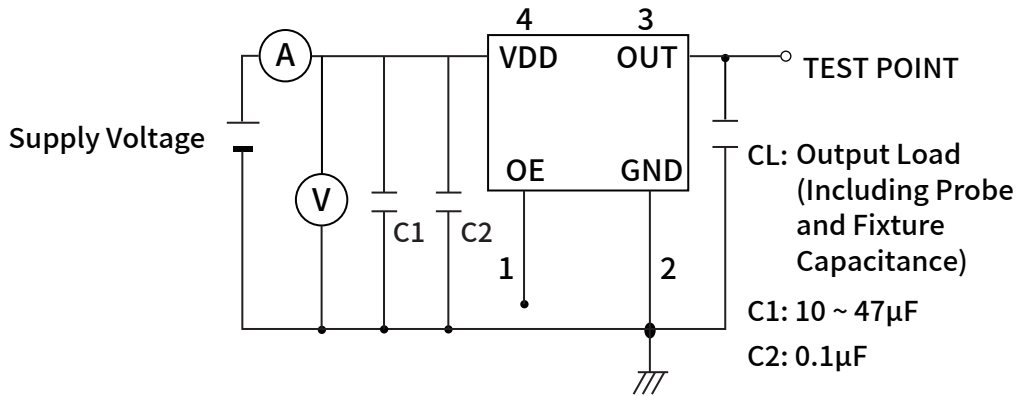

Notes: PIN 1 connected to Vdd or floating, the product is working properly; connected to GND, stops working.

## Waveform Conditions

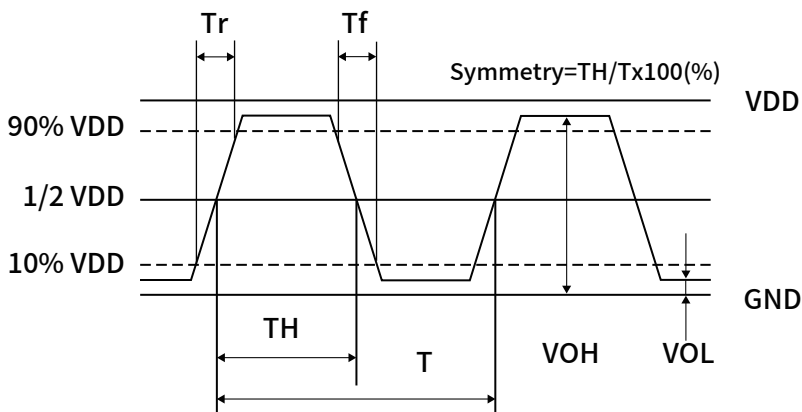

Waveform measurement system should have a min. bandwidth of 5 times the frequency being tested.

## Reliability Specification

NO.	Item	Conditions	Basis of Verdict
1	Drop	High:100cm;Thickness:3cm;3 times.	$\Delta FL \leq \pm 5 \text{ppm}$
2	Vibration	Frequency:10~500HZ speed:11min/cycle Amplitude:1.5mm(10~55Hz) acceleration rate:200m/s <sup>2</sup> (55~500Hz) Direction:X,Y,Z	$\Delta FL \leq \pm 5 \text{ppm}$
3	Low Temperature Storage	Temp:-40°C±2°C;Times:96h	$\Delta FL \leq \pm 5 \text{ppm}$
4	High Temperature Storage	Temp:125°C±2°C;Times:96h	$\Delta FL \leq \pm 5 \text{ppm}$
5	High Temp.&Humidity	Temp:80°C±2°C; Humidity:85%±5%;Times:1000h	$\Delta FL \leq \pm 5 \text{ppm}$
6	Thermal Shock	-40°C±2°C (30min) ↔ 85°C±2°C (30min) ; For 100 cycles	$\Delta FL \leq \pm 5 \text{ppm}$
7	Resistance to Soldering Heat	Keep 150 °C ± 5 °C 120s and then rose to 265 °C ± 5 °C for 10s,warming and holding time is less than the 200s, placed at room temperature 1 ~ 2h after test	$\Delta FL \leq \pm 5 \text{ppm}$
8	Aging	Temp:85°C;Times:30days	$\Delta FL \leq \pm 5 \text{ppm}$
9	Soldering Test	Dipping in solder bath at 245deg.C ± 5deg.C for 3±0.5 sec.	Soldering tin rate greater than 95%

# Ultra Low Phase Noise Crystal Oscillator



■ SOMC-330

## Taping Specifications

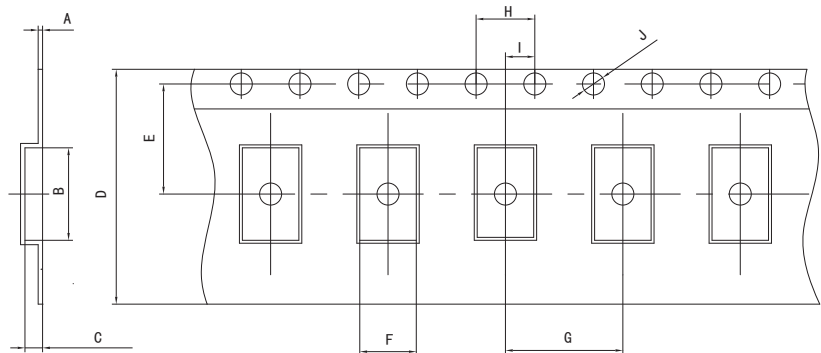
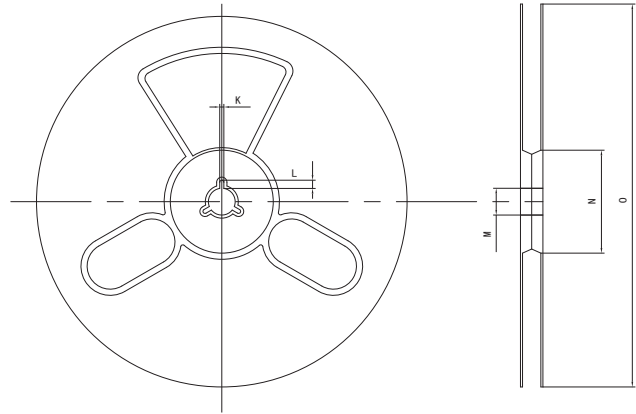

Pocket Tape Dimensions(mm)

Series	A	B	C	D	E	F	G	H	I	J	K	L	M	N	O
SOMC-330	0.35	14.35	4.90	24.00	11.50	9.35	16.00	4.00	2.00	1.50	2.00	4.00	13.00	60.00	180.00

## Packaging specifications

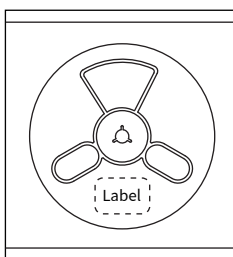

■ 800 pcs/reel

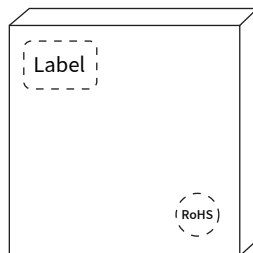

■ 1 reel/box

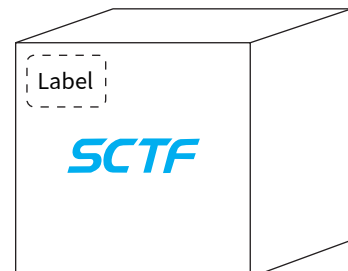

■ 10 box/carton

## SOMC-330

• Table 3: Phase Noise Plots (Unit: dBc/Hz)

Supply Voltage	Frequency (22.5792MHz)						
	10Hz	100Hz	1kHz	10kHz	100kHz	1MHz	5MHz
1.8V	-118.6280	-144.0379	-160.6510	-166.7798	-168.8862	-169.3245	-169.1343
3.3V	-113.7247	-143.0741	-165.1744	-171.8731	-174.4088	-174.7195	-174.5710

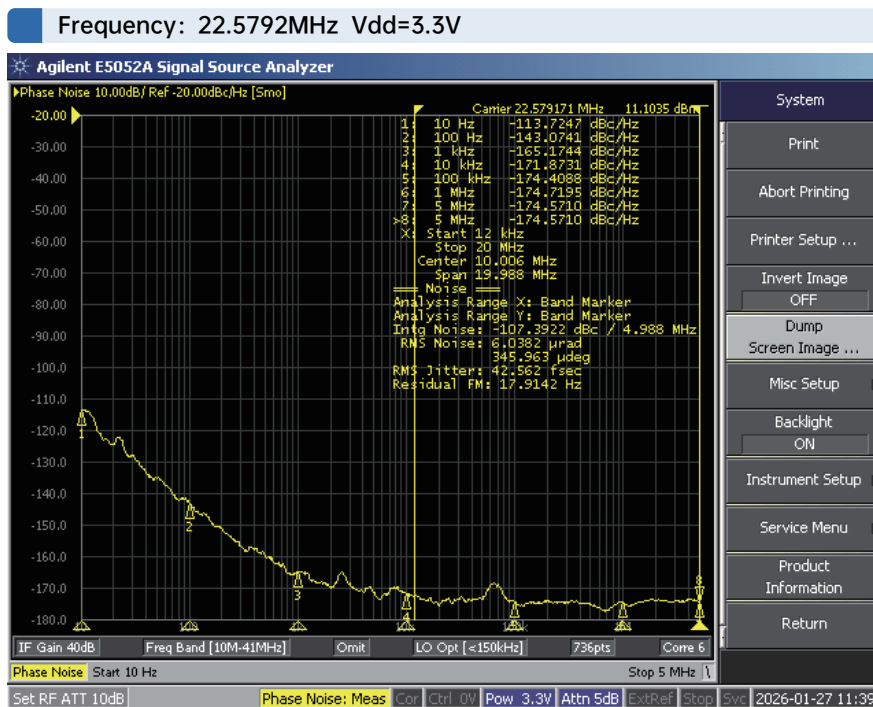
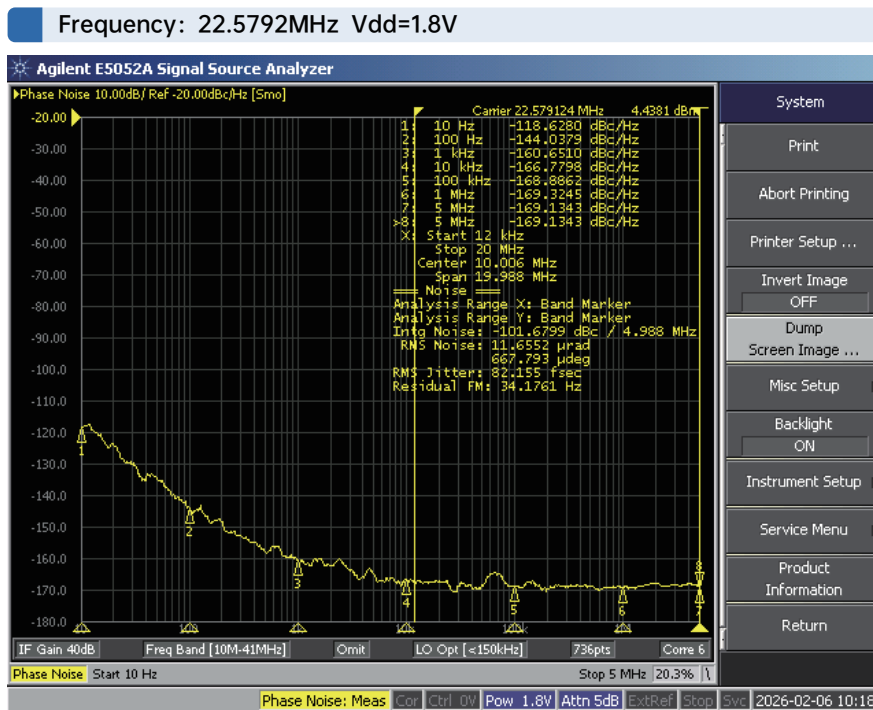

## SOMC-330

• Table 3: Phase Noise Plots (Unit: dBc/Hz)

Supply Voltage	Frequency (24.000MHz)						
	10Hz	100Hz	1kHz	10kHz	100kHz	1MHz	5MHz
1.8V	-105.2641	-137.4145	-159.8465	-165.6544	-169.2150	-168.5178	-168.4037
3.3V	-112.8081	-143.2328	-163.5475	-170.6182	-175.3342	-175.3239	-175.0770

Frequency: 24.000MHz Vdd=1.8V

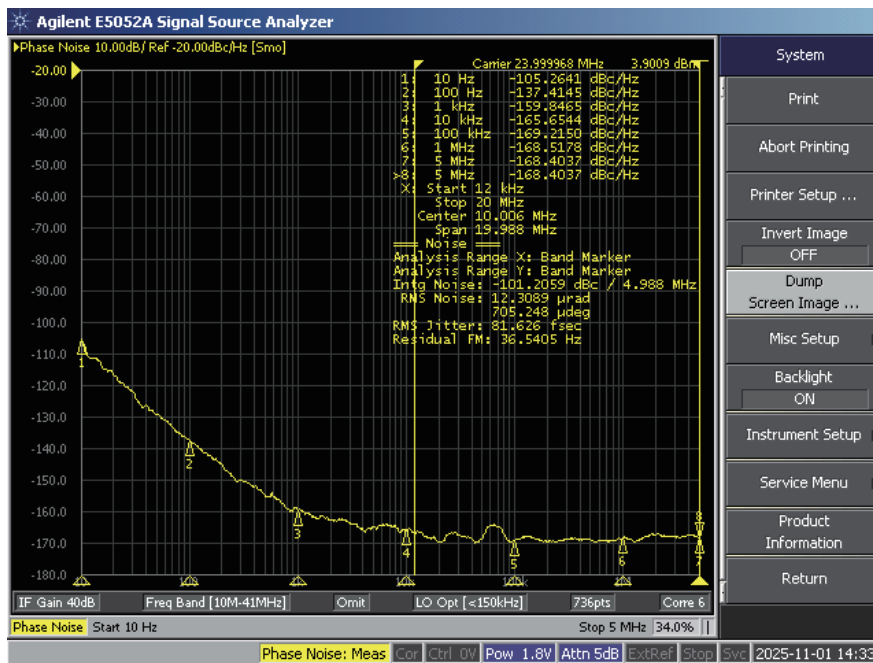

Frequency: 24.000MHz Vdd=3.3V



## SOMC-330

• Table 3: Phase Noise Plots (Unit: dBc/Hz)

Supply Voltage	Frequency (24.576MHz)						
	10Hz	100Hz	1kHz	10kHz	100kHz	1MHz	5MHz
1.8V	-111.9284	-139.1564	-159.8461	-165.8045	-170.6635	-168.6760	-168.3056
3.3V	-114.5849	-141.5066	-164.6962	-172.3016	-176.5909	-174.1533	-175.3109

Frequency: 24.576MHz Vdd=1.8V

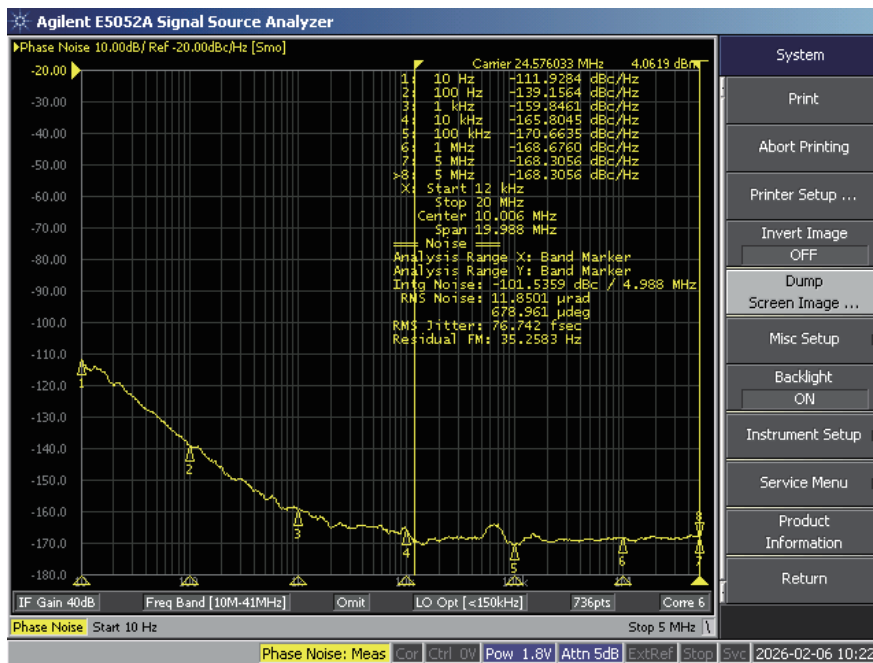

Frequency: 24.576MHz Vdd=3.3V

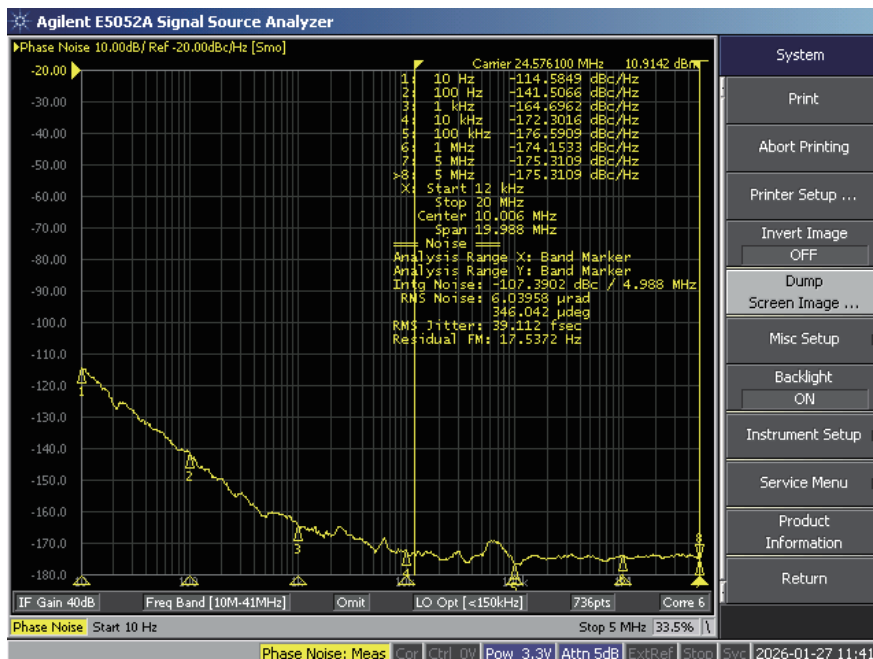

## SOMC-330

• Table 3: Phase Noise Plots (Unit: dBc/Hz)

Supply Voltage	Frequency (45.1584MHz)							
	10Hz	100Hz	1kHz	10kHz	100kHz	1MHz	10MHz	20MHz
1.8V	-103.3857	-133.8920	-158.4869	-165.4788	-166.9274	-166.9849	-167.7959	-167.6461
3.3V	-102.3225	-133.8389	-159.5504	-170.1787	-175.7962	-175.5260	-175.5061	-174.8307

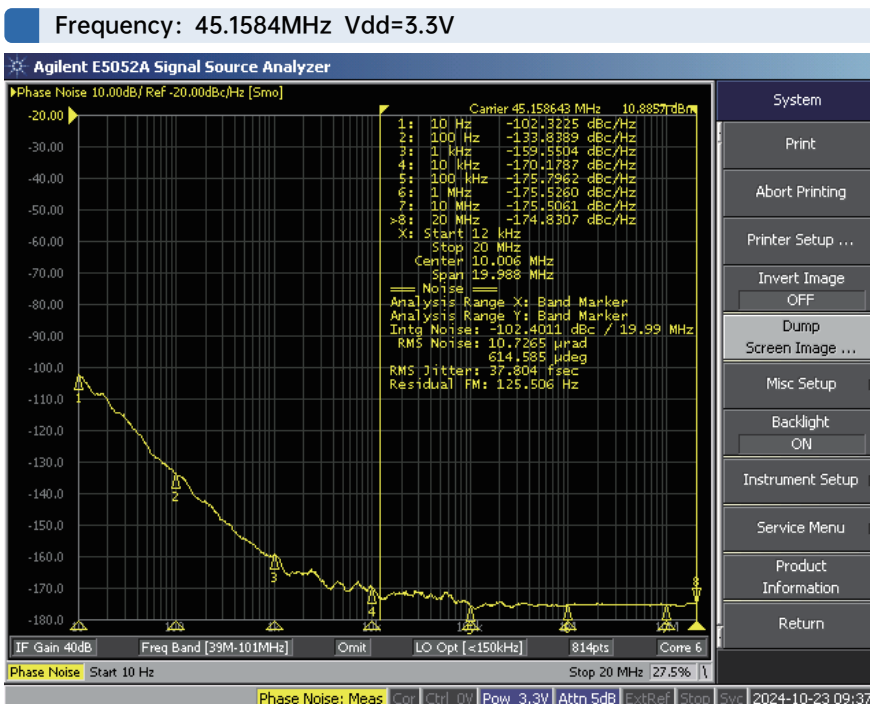
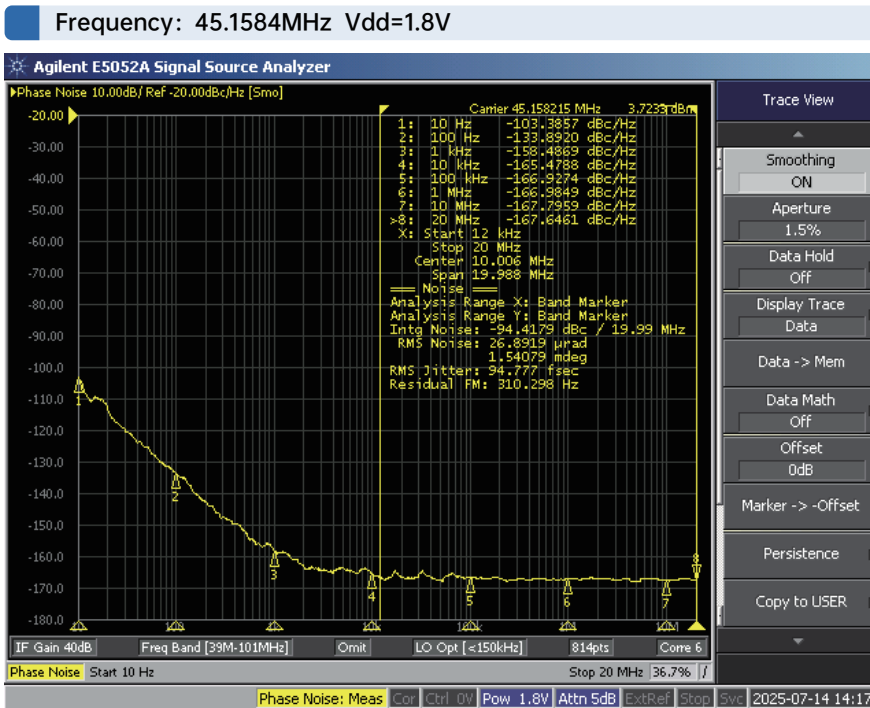

## SOMC-330

• Table 3: Phase Noise Plots (Unit: dBc/Hz)

Supply Voltage	Frequency (49.152MHz)							
	10Hz	100Hz	1kHz	10kHz	100kHz	1MHz	10MHz	20MHz
1.8V	-103.8869	-133.9334	-159.4565	-166.1006	-167.3752	-167.2250	-167.6746	-167.2080
3.3V	-100.1570	-133.9507	-162.4998	-168.5736	-175.1192	-175.1498	-174.9053	-174.9053

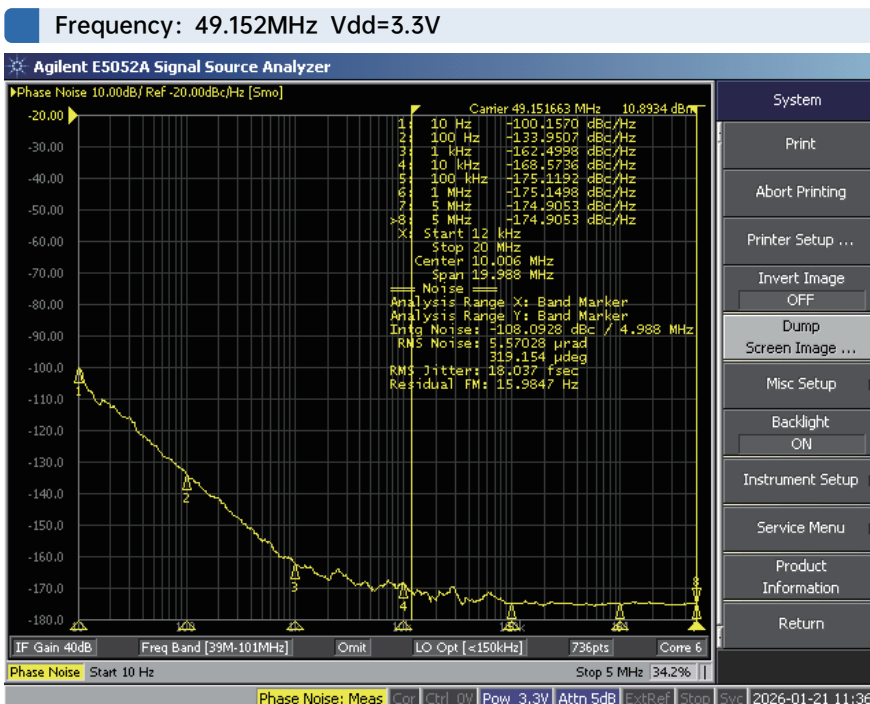
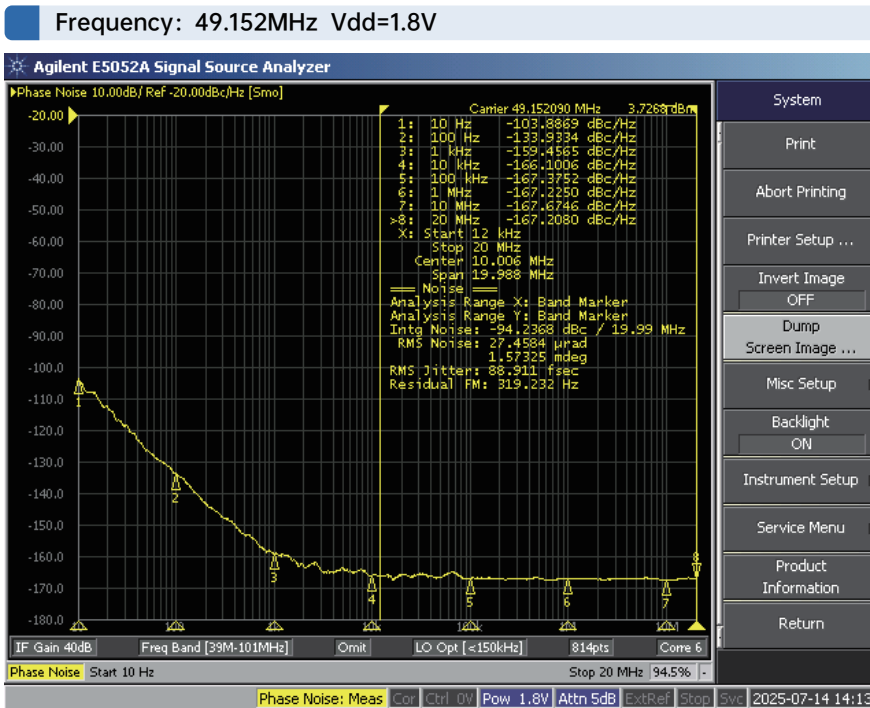

## SOMC-330

• Table 3: Phase Noise Plots (Unit: dBc/Hz)

Supply Voltage	Frequency (50.000MHz)							
	10Hz	100Hz	1kHz	10kHz	100kHz	1MHz	10MHz	20MHz
1.8V	-100.6799	-131.0586	-155.2559	-165.6411	-167.1478	-167.0924	-167.8074	-166.9701
3.3V	-101.6021	-131.2025	-161.0295	-170.9690	-175.3673	-174.6597	-175.5581	-174.8098

Frequency: 50.000MHz Vdd=1.8V

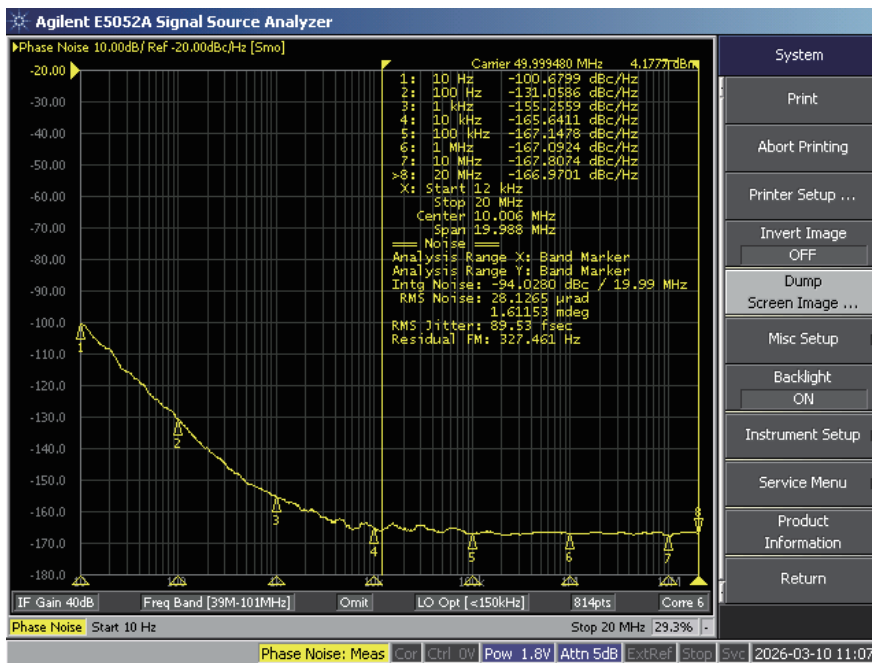

Frequency: 50.000MHz Vdd=3.3V

